



Industrial PC

PPC-A72-215-P



PN: CS19108R215P2

Content can change at anytime, check our website for latest information of this product.

www.chipsee.com

Contents

PPC-A72-215-P	3
1. Product Overview	7
2. Ordering Options	8
2.1. Operating System	8
2.2. Optional Features	9
3. Hardware Features	10
4. Power Input	12
5. Touch Screen	13
6. Connectivity	14
6.1. RS232+RS485+CAN+GPIO Connector	14
6.2. USB Connectors	17
6.3. LAN Connectors	18
6.4. WiFi & BT Module	19
6.5. 4G/LTE Module	20
7. TF Card Slot	22
8. Audio Connectors	23
9. Power Button	24
10. Mounting Procedure	25
11. Mechanical Specifications	26
12. Disclaimer	27
13. Technical Support	27

PPC-A72-215-P

Front View



Rear View



Side View 1



Side View 2



Product Overview

The Cortex[®]-A72/53 series PPC-A72-215-P (PN: CS19108R215P2) is a high-quality industrial panel PC. This single board computer features a 21.5" ten-point capacitive touch screen with a resolution of 1920 x 1080 pixels and brightness of 250 cd/m².

Key Applications

- Human Machine Interface HMI
- Mobile Applications
- Video Processing
- Machine Learning
- Video Gaming
- Process Control
- Process Monitoring
- ATM...

It is available both as an embedded solution and as a device housed in an aluminum casing with bezels, thus facilitating different installation options:

- Installation on an industrial cabinet
- Integration with the existing equipment

The PPC-A72-215-P Industrial Panel PC is based around the powerful CS-SOM-RK3399 System on Module (SoM), powered by the Rockchip RK3399 low-power processor which integrates a dual-core Cortex[®]-A72 and a quad-core Cortex[®]-A53 with a separate NEON coprocessor.

The RK3399 supports multi-format video decoders and has a high-performance dual-channel external memory interface (DDR3/DDR3L/LPDDR3/LPDDR4) capable of sustaining demanding memory bandwidths. It also provides a complete set of peripheral interfaces.

Ordering Options

Chipsee products can be customized during the ordering process. The product will be shipped with the pre-installed factory defaults if no extra requirements are specified. The table in the [Hardware Features](#) section provides information about the default options bundled with the product.

Note

You can order [PPC-A72-215-P](#) from the official [Chipsee Store](#) or from your nearest distributor.

Operating System

This product comes with a pre-installed OS of your choice. Please see the list below for the supported OSes, which can be also obtained from the [Software Documentation](#) section, along with the detailed installation instructions.

- Buildroot Linux Qt5.14*
- Android 7.1
- Android 11
- Debian 10

* (Formerly Chipsee Linux) Based on buildroot that has been integrated with:

1. Chipsee Hardware Test Application
2. An initialization script for GPIO/Buzzer/Audio
3. Multiple libraries, such as the `libQt5Sql` to develop Qt application with SQL
4. Various packages, such as the `ntfs-3g` to use NTFS file system

Warning

The [Software Documentation](#) section provides a detailed instruction on how to install different OSes on your own. However, bear in mind that Chipsee can't take the responsibility of inadequate installation procedure. If you "brick" your device, please contact Chipsee Technical Support at support@chipsee.com for further assistance

Optional Features

The PPC-A72-215-P Industrial Panel PC does not include 4G/LTE module by default. The module is optional and can be selected at the Chipsee store during the ordering process.

Warning

Installation, repair, and maintenance tasks should be performed by trained personnel only.
Chipsee does not bear any responsibility for damage caused by inadequate handling of the product.

Hardware Features

The PPC-A72-215-P Industrial Panel PC offers a broad range of performance and connectivity options for scalable integration, providing expandability to meet future needs. Some of the key features are listed in the table below.

PPC-A72-215-P	
CPU	Rockchip RK3399, Dual-core Cortex-A72 (1.8GHz), Quad-core Cortex-A53 (1.4GHz)
RAM	4GB DDR3
eMMC	16GB
Storage	TF Card, Supports up to 128GB SDHC
Display	21.5" LCD, 1920 x 1080, High Brightness: 250 cd/m ²
Touch	10-point capacitive touch screen
USB	1 x USB 2.0 HOST, 1 x USB 3.0 HOST, 1 x USB Type-C
LAN	1 x RJ45, GbE
Audio	3.5mm Audio In/Out Connector, 2W Internal Speaker
Buzzer	Yes
RTC	Yes
RS232	3 x RS232 (Optional 5 x RS232 at most, 1 debug port) ¹
RS485	2 x RS485 ¹
GPIO	8 Channels
WiFi/BT	Integrated WiFi/BT Module
4G/LTE	Supported, Optional
Power Input	From 12V to 36V
Current	2.2A Max
Power Consumption	16W Typical, 26.4W Max
Working Temperature	From 0°C to +50°C
OS	Android 7.1, Android 11, Buildroot Linux Qt5.14, Debian 10
Dimensions	PPC-A72-215-P (PN: CS19108R215P2): 535 x 331 x 52.5mm
Weight	PPC-A72-215-P (PN: CS19108R215P2): 5500g
Mounting	PPC-A72-215-P (PN: CS19108R215P2): Panel, VESA

Table 162 Key Features

1(1,2)

This product has 5 x UART channels in total. The default configuration is 3 x RS232 and 2 x RS485, including 1 debug port. UART can be swapped between RS232 and RS485 modes easily, so if you need a different RS232/RS485 configuration, please get in touch with the Chipsee Technical Support at support@chipsee.com

Power Input

The PPC-A72-215-P Industrial Panel PC can be powered by a wide range of input voltages: From 12V to 36V DC. The power input connector is a **3-pin, 3.81mm terminal**.

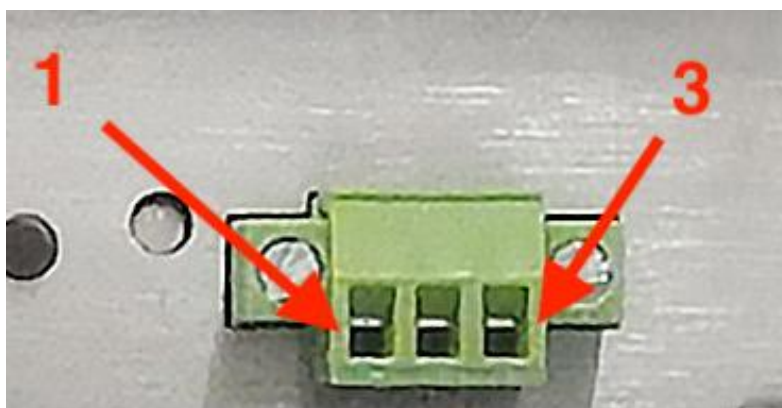

Power Input

Note that the “+” sign represents the positive power input, and it is printed both at the casing and as a silk-screen on a PCB of the embedded version. The “-” terminal is shorted to the ground.

Power Input Definition		
Pin Number	Definition	Description
Pin 1	Positive Input	DC Power Positive Terminal
Pin 2	Negative Input	DC Power Negative Terminal
Pin 3	Ground	Power System Ground

Table 163 Power Connector

Note

The system ground “G” is connected to power negative “-” on board.

Touch Screen

The PPC-A72-215-P Industrial Panel PC uses a 10-point capacitive touch screen.

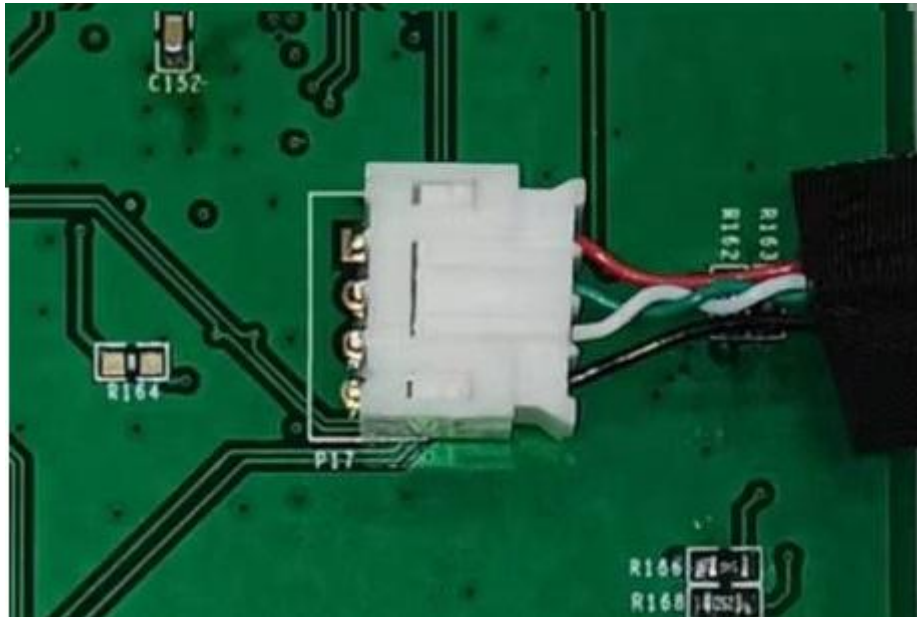

Figure 503: *Capacitive Touch Screen Connector*

Attention

A capacitive touch screen is susceptible to power noise and Electromagnetic Radiation (EMR). It may cause LCD ripples or even capacitive touch malfunction. If using a capacitive multi-touch test application, you might notice the touch points float erratically across the display. There are several solutions to this problem:

1. Use a high-quality Power Adapter Unit (PSU) with low EMR. You can also provide power from a battery.
2. Make sure that the PPC-A72-215-P Power Input connector (pin 3) is properly connected to the Power System Ground to provide sufficient EMI shielding and eliminate the problem entirely.
3. Bad GND problems can also be confirmed by touching pin 3 of the Power Input connector with one hand while operating the capacitive touch screen with the other hand. In this case, the operator's body acts as the Power System Ground.

Connectivity

There are many connectivity options available on the PPC-A72-215-P industrial PC. It has 1 x USB 2.0 HOST, 1 x USB 3.0 HOST, 1 x USB Type-C, 1 x network connector (RJ45) supporting up to 1 Gbps, 8 x GPIO and 5 x UART terminals (RS232/485).

RS232+RS485+CAN+GPIO Connector

The serial communication interfaces (RS485, RS232, and CAN) are routed to a **12-pin 3.81mm terminal**, as illustrated in the figure below. Serial communication on both RS485 and RS232 interfaces can reach up to 115200 kbps.

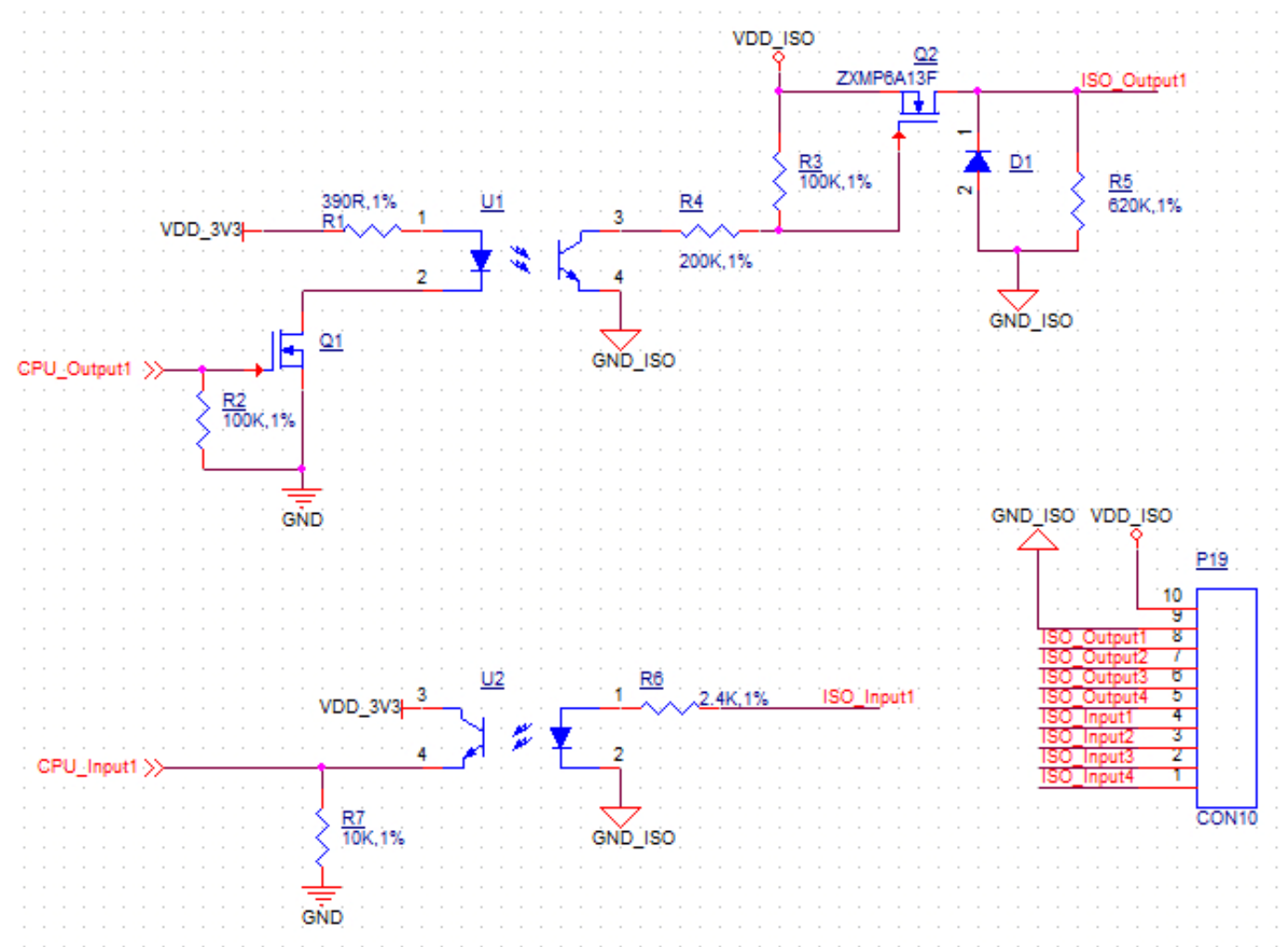

Isolated GPIO reduced schematic

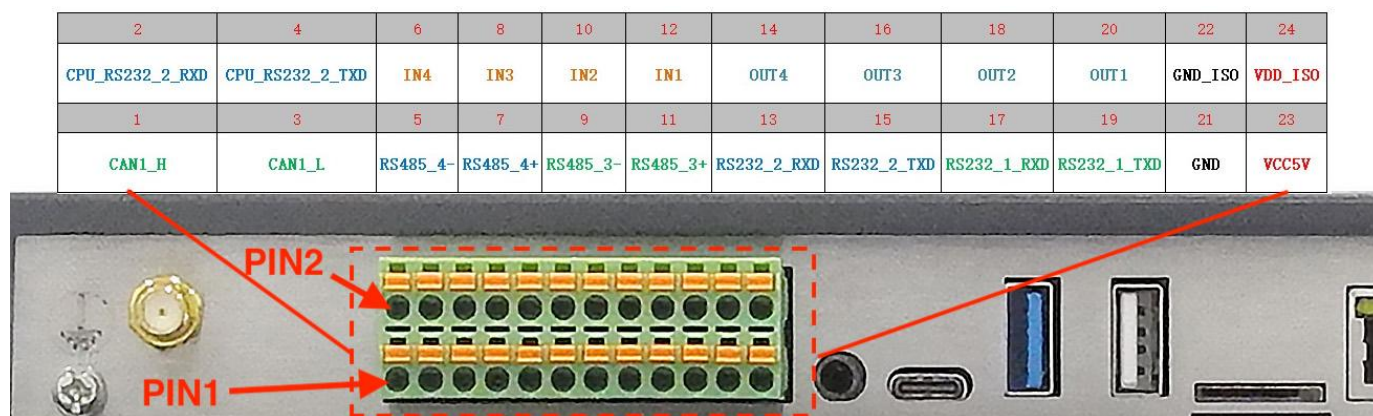

The table below offers more detailed description of every pin and its definition:

RS232 / RS485 / CAN / GPIO Pin Definition:		
Pin Number	Definition	Description
Pin 1	CAN1_H	CAN H signal
Pin 2	CPU_RS232_2_RXD	CPU UART2, CPU RS232 RXD signal
Pin 3	CAN1_L	CAN L signal
Pin 4	CPU_RS232_2_TXD	CPU UART2, CPU RS232 TXD signal
Pin 5	RS485_4-	USB UART4, RS485 -(B) signal
Pin 6	IN4	Isolated Input 4
Pin 7	RS485_4+	USB UART4, RS485 +(A) signal
Pin 8	IN3	Isolated Input 3
Pin 9	RS485_3-	USB UART3, RS485 -(B) signal
Pin 10	IN2	Isolated Input 2
Pin 11	RS485_3+	USB UART3, RS485 +(A) signal
Pin 12	IN1	Isolated Input 1
Pin 13	RS232_2_RXD	USB UART2, RS232 RXD signal
Pin 14	OUT4	Isolated Output 4
Pin 15	RS232_2_TXD	USB UART2, RS232 TXD signal
Pin 16	OUT3	Isolated Output 3
Pin 17	RS232_1_RXD	USB UART1, RS232 RXD signal
Pin 18	OUT2	Isolated Output 2
Pin 19	RS232_1_TXD	USB UART1, RS232 TXD signal
Pin 20	OUT1	Isolated Output 1
Pin 21	GND	System Ground
Pin 22	GND_ISO	Isolated Ground
Pin 23	VCC5V	System 5V output, up to 1A

RS232 / RS485 / CAN / GPIO Pin Definition:		
Pin 24	VDD_ISO	Isolated Power Input,support 5V~24V

Table 164 Connectivity Section

 **Attention**

- The 120Ω match resistor for **CAN** bus is **NOT mounted** by default.
- The 120Ω match resistor for **RS485** is **already mounted** by default.
- This product supports changing 2 x RS485 to 2 x RS232 and supports up to 5 x RS232 (include one debug port).
- The GPIO has been opt-isolated, you can use an external isolated power input but the power input range should be from 5V to 24V DC.
- The 4 output channels can drive at most 500mA current on each channel.

USB Connectors

There are 2 x **USB HOST connectors** onboard which includes 1 x USB 2.0 HOST, 1 x USB 3.0 HOST, 1 x USB Type-C , as shown in the figures below.

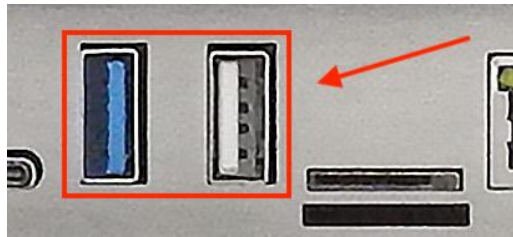

USB 2.0 and USB 3.0 HOST Connectors (enclosed PC version)

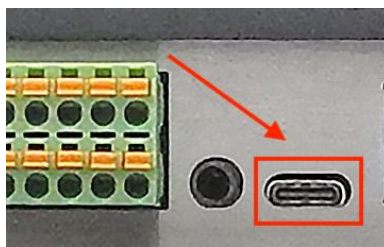

USB Type-C Connector (enclosed PC version)

Warning

Be careful not to touch surrounding electronic components accidentally while plugging in USB devices into the embedded IPC version.

LAN Connectors

LAN (RJ45) connector provides Ethernet connectivity over standardized Ethernet cables as shown in the figure below. The integrated Ethernet interface supports up to 1 Gbps data throughput.

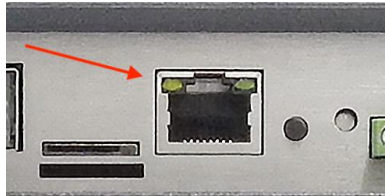

RJ45 LAN Connector

Note

Use CAT5 or better cables to achieve full data throughput over maximum distance defined by the 1000BASE-T standard (100m).

WiFi & BT Module

The PPC-A72-215-P Industrial Panel PC is equipped with the popular **Realtek RTL8723 WiFi/BT module** that supports BT/BLE 4.0 (with backward compatibility), as well as 802.11bgn 2.4 GHz Wireless LAN (WLAN).

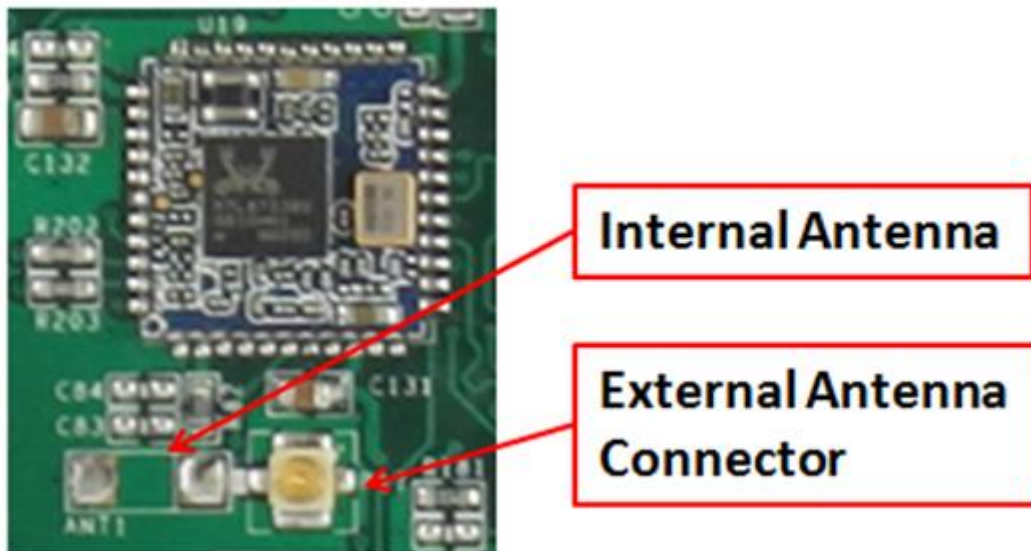
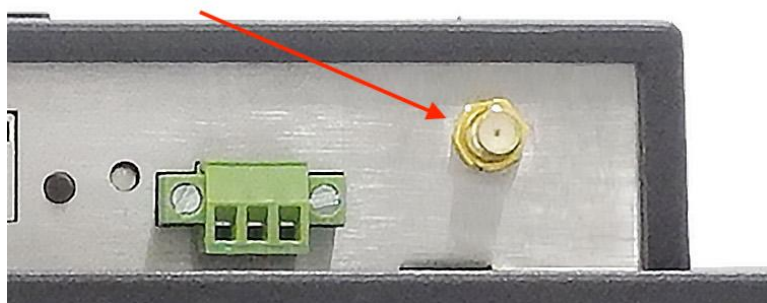

Figure 504: *RTL8723 WiFi/BT Module*

The product includes an SMA connector for an external WiFi/BT antenna, as illustrated in the figure below.



WiFi+BT Antenna SMA

4G/LTE Module

The PPC-A72-215-P Industrial Panel PC is equipped with a **mini-PCIe connector** that can connect to a 4G/LTE module. The customer will also need a SIM Card Holder and a 4G/LTE Antenna Connector to ensure 4G/LTE works on the PPC-A72-215-P. SIM card does NOT support hot plug. Power off before inserting or removing SIM card.



Figure 505: mini-PCIe Connector & 4G Module

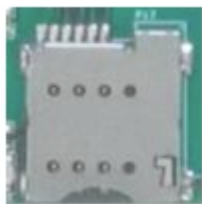
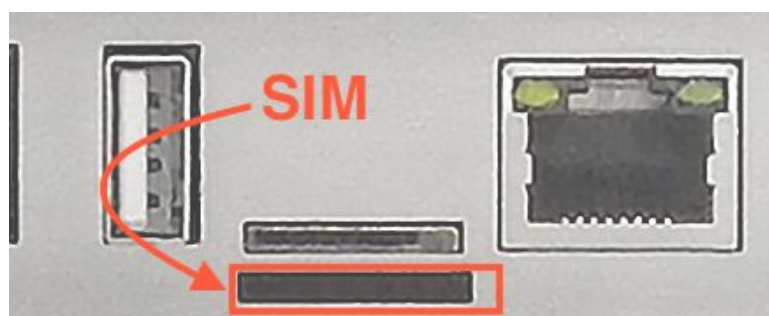
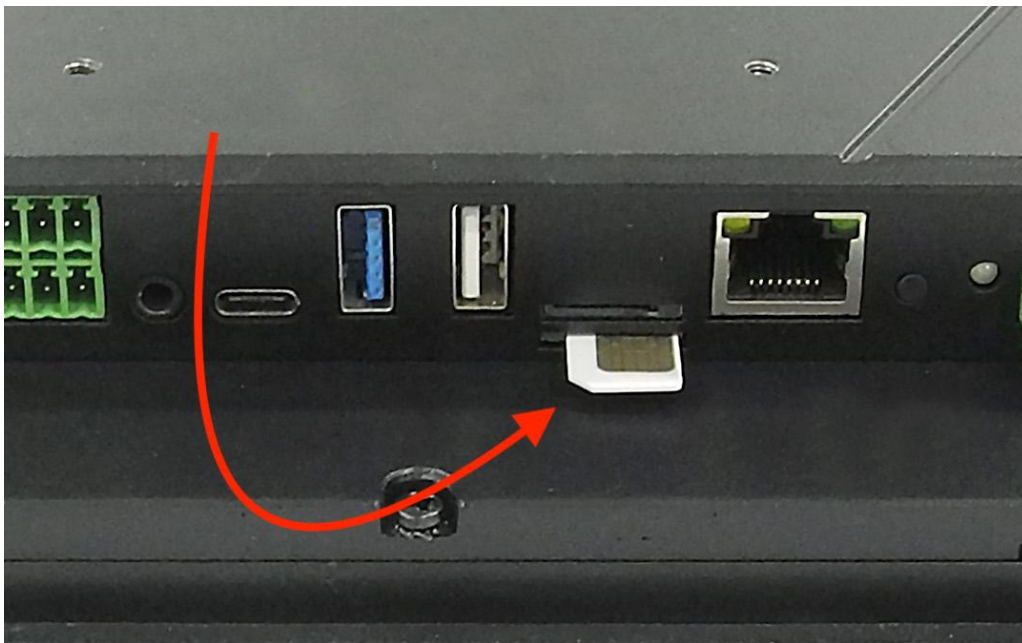

Figure 506: SIM Card Holder & 4G Antenna



SIM Card Holder



SIM Card Direction

⚠ Attention

The product does not come shipped with the 4G/LTE module by default.

TF Card Slot

The PPC-A72-215-P Industrial Panel PC features 1 x **TF Card (micro SD) slot**. It can address up to 128GB of memory.

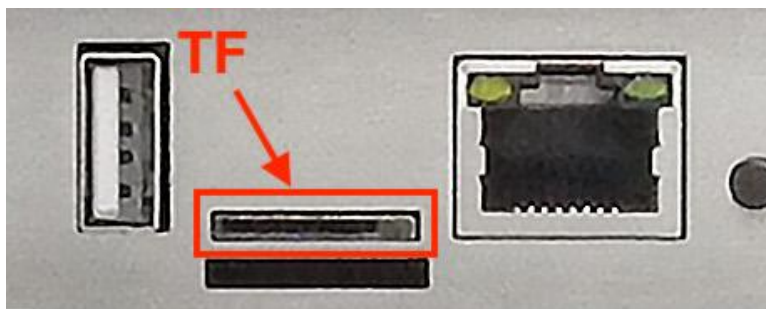

TF (micro SD) Card Slot

Note

The product does not come shipped with the TF Card by default.

Audio Connectors

The PPC-A72-215-P Industrial Panel PC features some audio peripherals. It has a **3.5mm audio input/output jack**, an **internal speaker**, as well as a small **buzzer**.

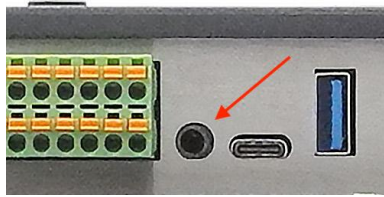

Audio Connector (enclosed PC version)

Attention

By plugging in the headphone cable, the internal speaker will be disabled automatically.

The miniature 2W embedded speaker is handy for audio reproduction, the small buzzer can play alarm/notification sounds.

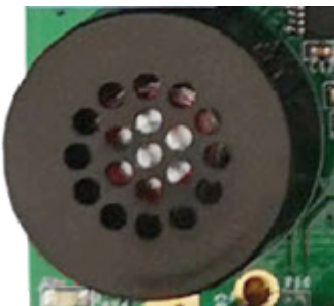
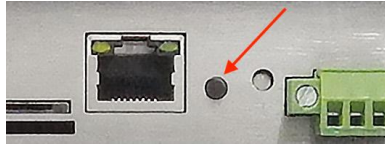

Figure 507: 2W Micro Speaker and Buzzer

Power Button

The PPC-A72-215-P Industrial Panel PC has a power button, as shown on the figure below. You can use the button to power ON or OFF the industrial PC.



Power Button

Mounting Procedure

The PPC-A72-215-P Industrial Panel PC can be mounted with 4 x **M4** (6mm) screws using the **VESA** (100x100mm or 75x75mm).

The PPC-A72-215-P Industrial Panel PC can be mounted with **panel mounting** method, enabling simplified installation onto any standard mounting fixture.

Attention

Please make sure the display is not exposed to high pressure when mounting into an enclosure.

You can find detailed information about mounting in the [Mount IPC Guide](#).

Mechanical Specifications

For PPC-A72-215-P, the outer mechanical dimensions are 535 x 331 x 52.5mm (W x L x H).

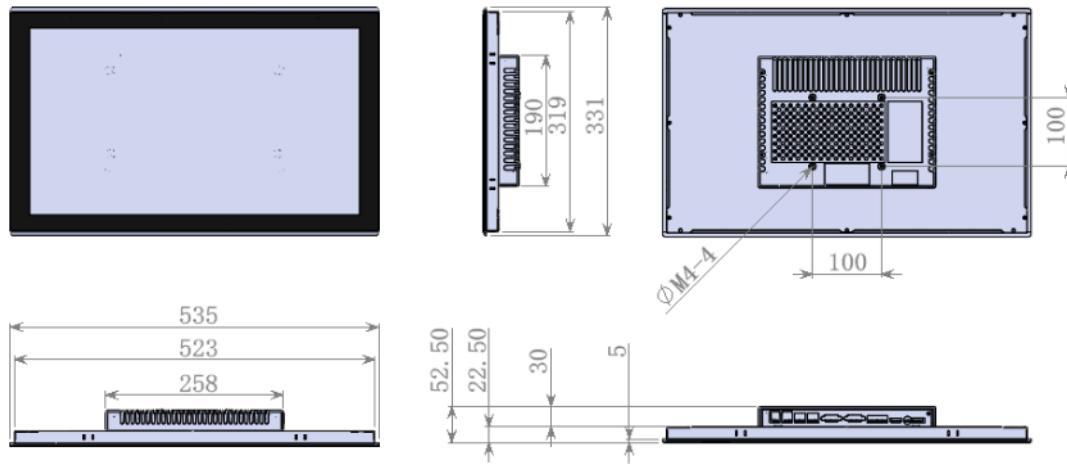

Mechanical Drawing (PPC-A72-215-P)

Disclaimer

This document is provided strictly for informational purposes. Its contents are subject to change without notice. Chipsee assumes no responsibility for any errors that may occur in this document. Furthermore, Chipsee reserves the right to alter the hardware, software, and/or specifications set forth herein at any time without prior notice and undertakes no obligation to update the information contained in this document.

While every effort has been made to ensure the accuracy of the information contained herein, this document is not guaranteed to be error-free. Further, it does not offer any warranties or conditions, whether expressed orally or implied in law, including implied warranties and conditions of merchantability or fitness for a particular purpose. We specifically disclaim any liability with respect to this document, and no contractual obligations are formed either directly or indirectly by this document.

Despite our best efforts to maintain the accuracy of the information in this document, we assume no responsibility for errors or omissions, nor for damages resulting from the use of the information herein. Please note that Chipsee products are not authorized for use as critical components in life support devices or systems.

Technical Support

If you encounter any difficulties or have questions related to this document, we encourage you to refer to our other documentation for potential solutions. If you cannot find the solution you're looking for, feel free to contact us. Please email Chipsee Technical Support at support@chipsee.com, providing all relevant information. We value your queries and suggestions and are committed to providing you with the assistance you require.